

Criador Labs

Product Development

Company Introduction



Criador Labs is a complete product development consultancy and design studio which is built on a foundation of innovation. Our expertise is gained from hands on experience of every stage the product development life cycle. We combine creative innovation with engineering expertise to help you create unique new products.

About us



Our Vision

We make dreams possible. We seek to bring high-quality product design within the reach of all innovators – whoever and wherever in the world you are. We strive to empower you to bring the next generation of breakthrough products to market

Who we are.

A talented team of industrial designers, engineers and Geeks dedicated to bringing your products to life

What we do.

We help you get your product design ideas off the ground by working with you to tease out your ideas and transform them into innovative design.

How we work.

We have a flexible, step-by-step approach to product design. We will guide you through the process; you simply choose how much of our help you use.



Services



Design Research

We collect the details of your idea and your target customers to identify a set of end users' needs and ensure the correct product focus. We create a record of requirements and build the case for the product specifications.



Concept Development

We develop multiple concepts and evaluate the comparative strengths and weaknesses of the concepts. Together, we will then proceed to select one or more concepts for further testing and development and develop a "looks like" model without any functionality.



Design Development

The design phase incorporates a number of key stages including the Industrial Design (Sketching, Concept Design) and the Technology Design (3D CAD, Electronics, App, Simulations, 2D Drafting or 'manufacturer's sketches').



Prototype and Testing

We will develop a physical prototype, a fully-functional pre-production version of the product, or the first approximation of the product. We then test the prototype and make modifications to the design if required, before producing a final working prototype.

The startup agency advantage



New Technology Adoption
(Open to explore)



Quick Turnaround
(Faster response and completion time)



Competitive Pricing
(We have less overhead)



Quality
(Focus on one thing)

New Product Development Process

1 Share Your Idea

We will listen carefully to your product idea to understand your vision. We then share our queries with you so that we all are on the same page.

2 User Research

Once we have taken all the details from you, we will work on product idea feasibility and perform analysis from the end-user perspective.

3 Concept Development

Once we have finalized all the requirements for the product, we will proceed to generate several design concepts. We will test and select the best one according to the technical feasibility and market acceptance of the product.

4 Industrial Design

After finalizing the product features, we will work on industrial design. Here, our main focus will be "how can we make an aesthetically stunning product with a modern look and feel?" We present you with sketches and graphic designs.

5 Technology Design

After ID, we will work on the CAD, Electronics, Application, Cloud of the product. We will perform simulations on various product aspects before finalizing the CAD Drawings and Bill of Materials (BOM). In short, we will work on a Design for Manufacturing. Your design is now ready for prototyping and mass production.

6 Prototyping and Testing

After the CAD is finalized, we will make a prototype with the help of different technologies (3D Printing, CNC, Polyurethane etc.) and produce a report of test results. We will make any updates to the CAD files that are

7 Batch Manufacturing

Once you approve the prototype, you are ready for small batch manufacturing. We work with partner contract manufacturers, who can work on small quantity runs, so that you can test your product and test the market before mass production.

8 Manufacturing Consultancy

If you are ready to proceed to manufacturing, we will help you select the best manufacturer at an affordable cost. We will collect quotes from different manufacturers (in India and China) and analyze the best fit for the manufacturing of your product.

Case Study

Market Crusier



Shopping Cart Company :Market Cruiser
Client Name : Fritz Rollins

INITIAL
CONCEPT

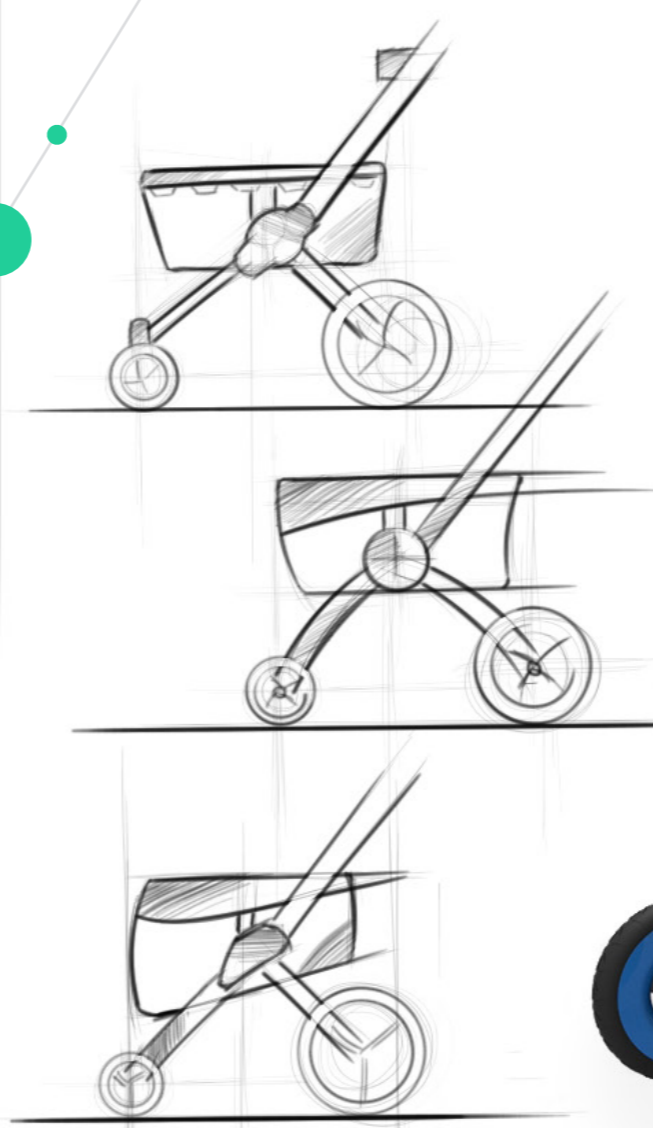

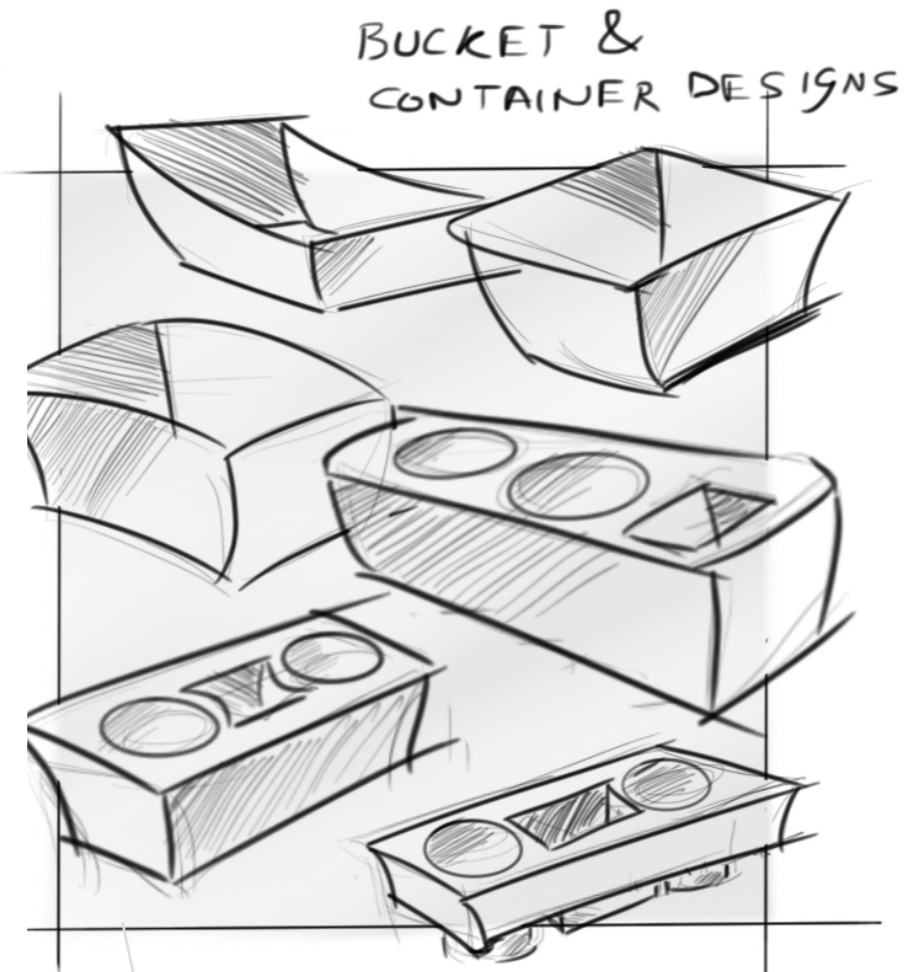
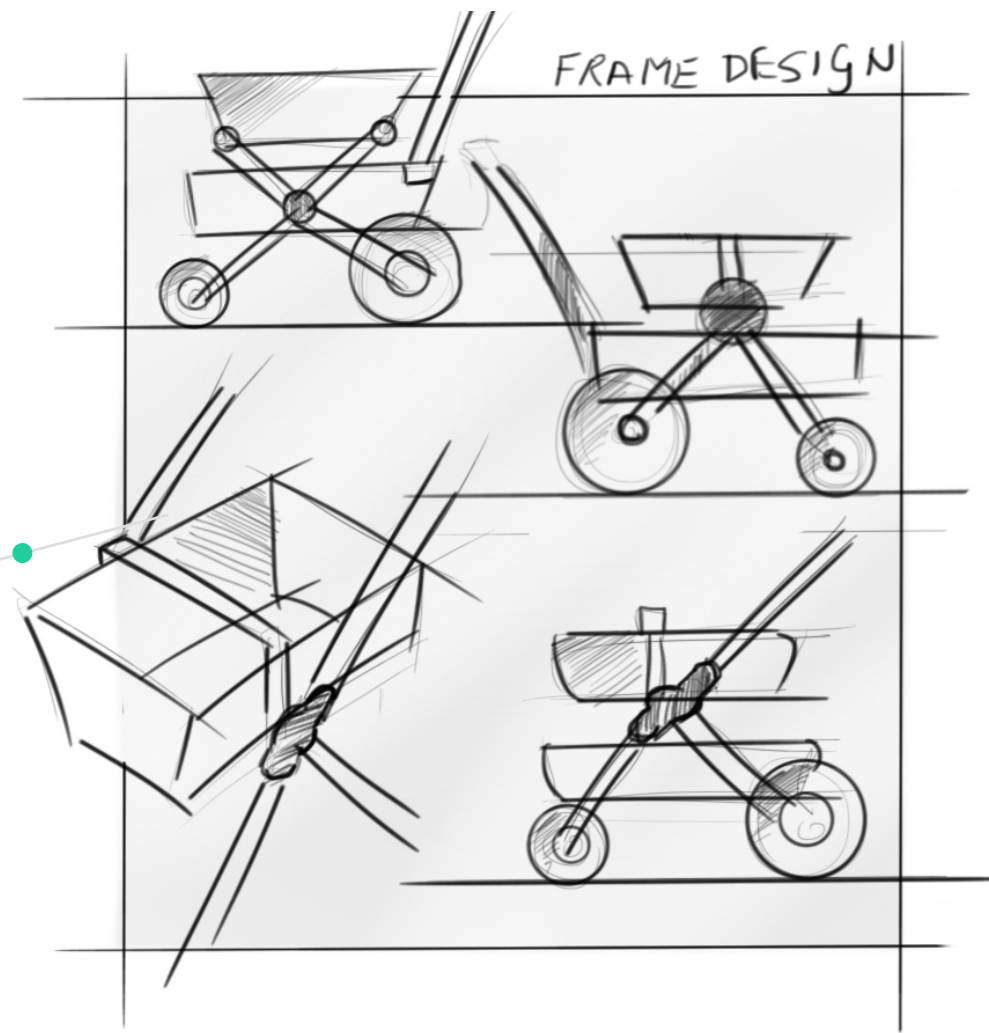

Ideation & conceptualisation

DETAILING & FINAL DESIGN

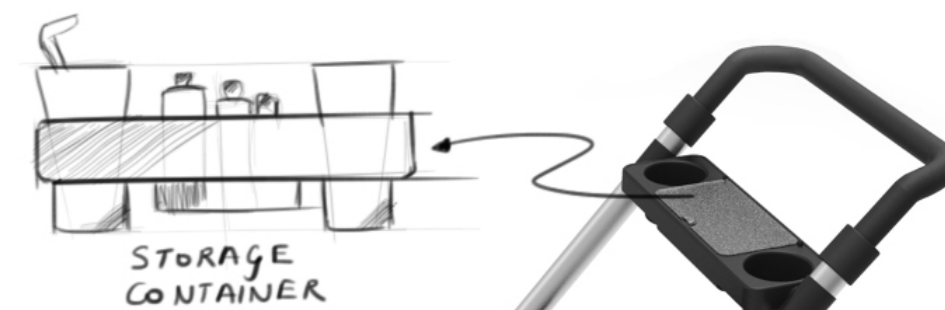
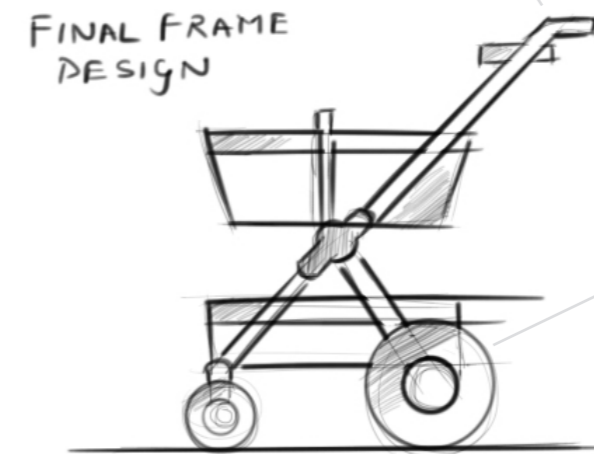
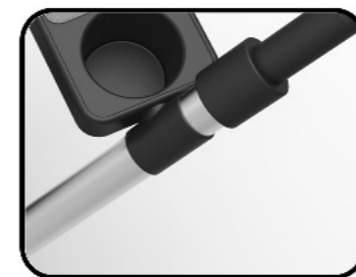
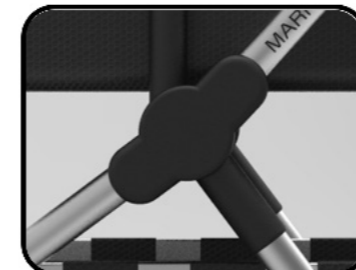



Case Study
**Ardunio
Enclosure**



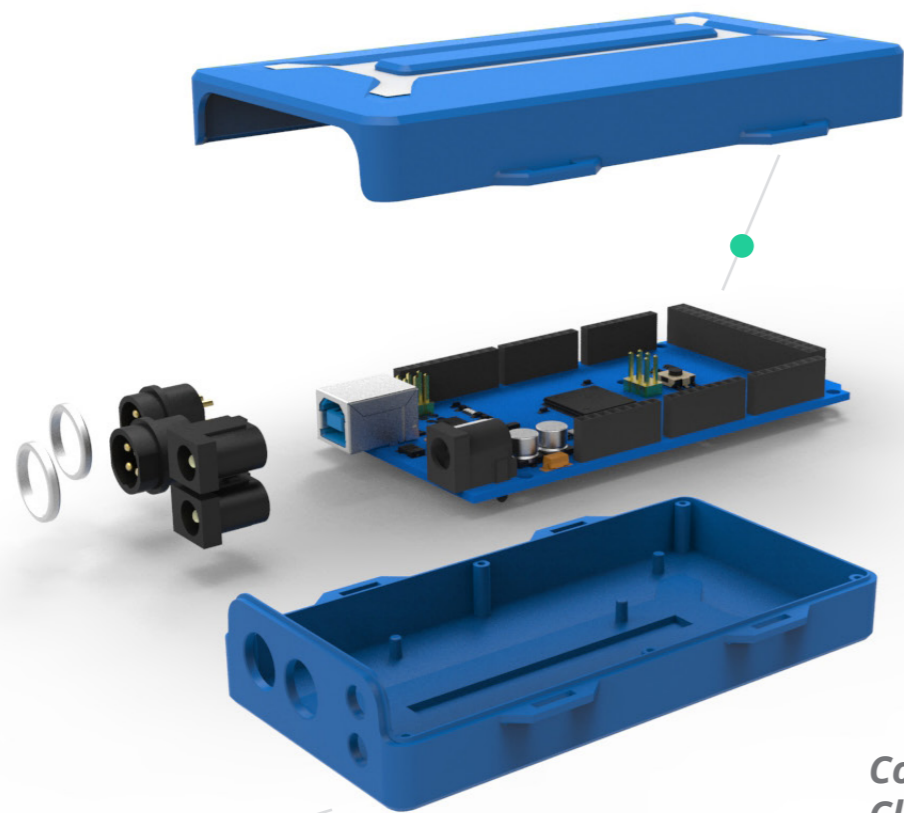

*Company Name : Sinfosy
Client Name : Karsten Koenigstein*



Ardunio Enclosure

- casing for a micro controller
- inner case diameters about 60 x 35 x 120 mm
- protection class IP67
- external connectors
- power supply (15 V),
- electronic cable, USB
- stackable
- producable by injection molding
- moderate production costs

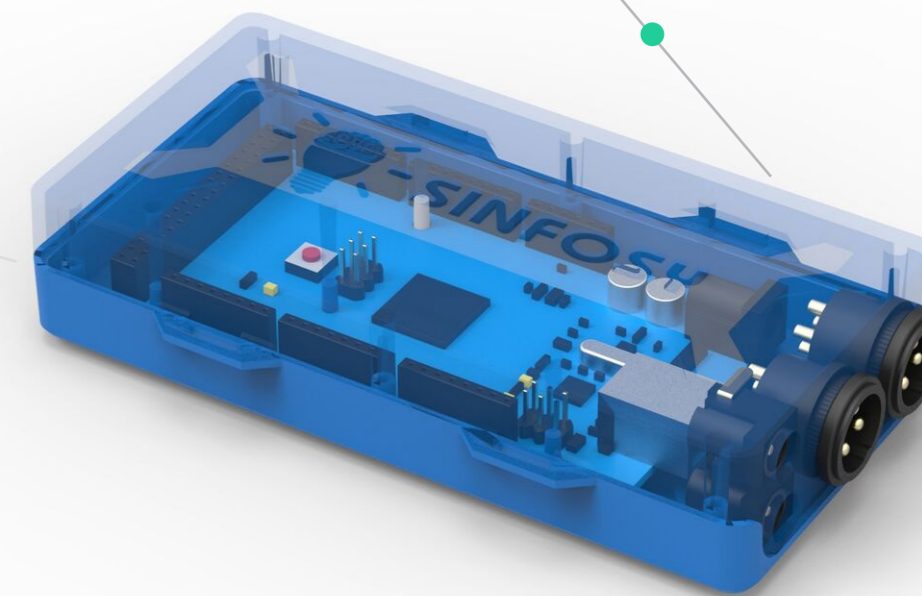



Case Study
**Herb
Grinder**



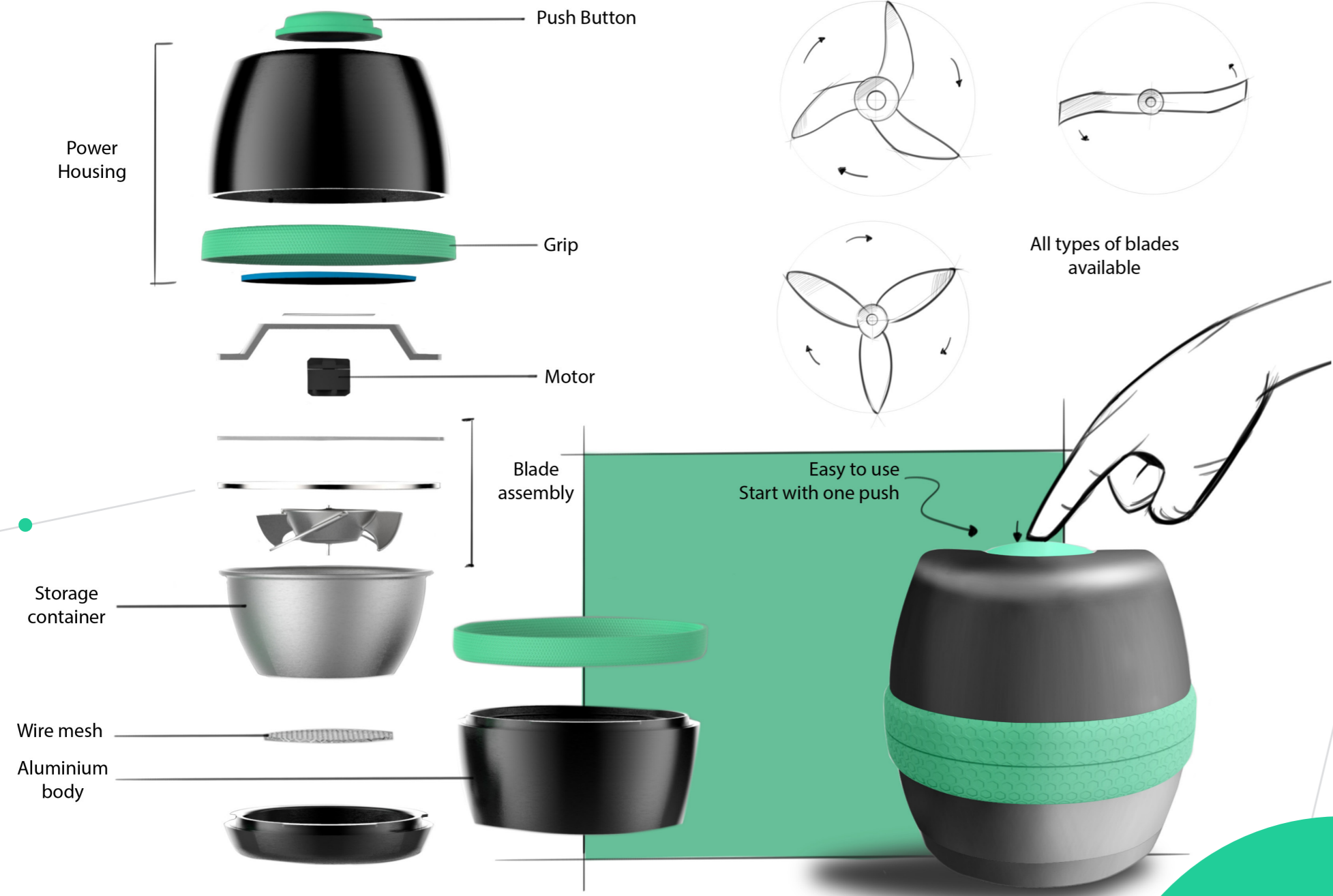

DETAILING AND CONCEPT DESIGN



Company : Aurora
Client Name : Nick Booth

Case Study
Cubby Shaker



Ideation

Initial Inspiration

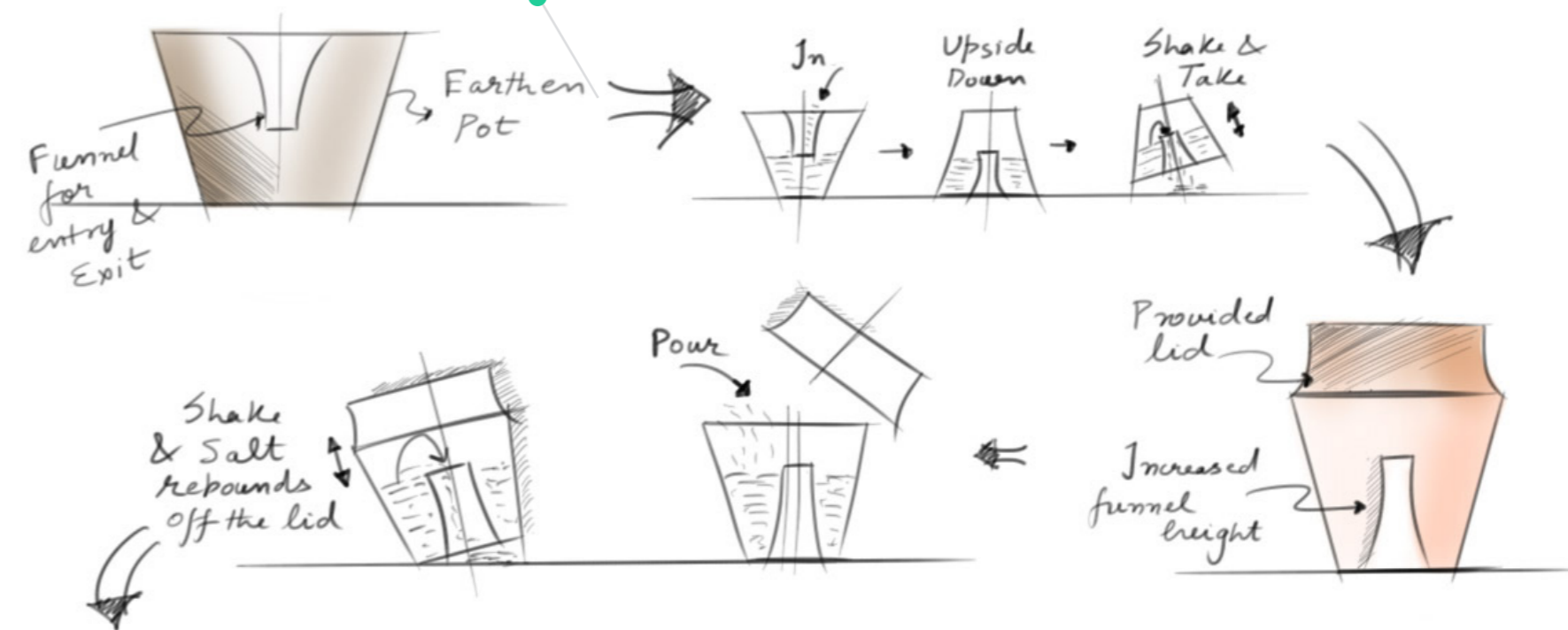

Form Explorations

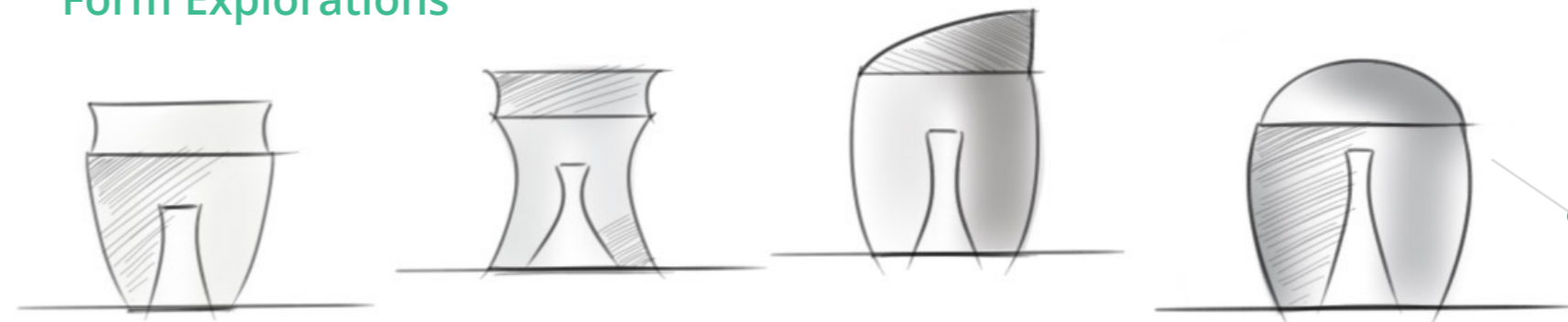

Explorations

Different materials, textures and colors were explored during the conceptualisation phase. Finally, Tritan material with transparency were chosen.

Features:

Moisture free, No clogging and high material quality

Final Product & Dimensions

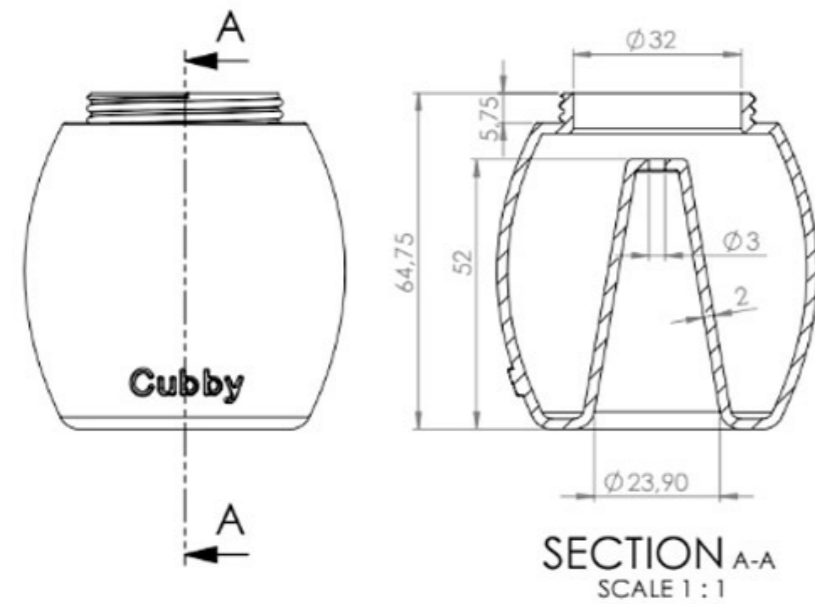

DETAILING AND CONCEPT DESIGN



Prototyping

The prototype was 3d printed and was checked for its functionality as well as tested with users for the ease of use and likability of the product.



Packaging

The packaging was kept to be transparent to showcase the elegance of the product. Also the use of basic shapes kept it very simple to rotate to.

*Company : Creative Cook and Co Ptv Ltd
Client Name : Sharyn Co*

Portfolio Designs

Hair Remover

- Battery Powered
- Handheld
- No Blades
- Thumb Power Button
- 4 Hours Battery Life



Concept Design



Awakey: Smart Door Lock

- Smartphone operable Smart Lock (BLE 4.0)
- Runs on AA Batteries
- Installs on Wooden Doors
- Add & Remove Users
- Access Monitoring
- Activity Notifications
- Up to 50 Electronic Keys



Final Design

Awakey Tech

Client Name : Ankit Jain

Projector

- Portable projector
- Water, dust & drop resistant
- Rechargeable
- Inbuilt Speake



Company: OMPT
www.ompt.org
Client Name: Matt York,
Executive Director

Wireless Webcam

- Easy Connectivity
- Specially design for home (Women, Kids, Couples,)
- 360 degree rotation
- Battery Powered
- Obviously wireless



Client Name : Gurmeet Singh

Testimonials

Great to work with. Great support. Very knowledgeable. Worked with our engineer quickly to get things done.

Alex Schlaferman - Founder of Vante Toys

An excellent partner to work with; very fast response and quick understanding of a system that must be completely new to them. Highly recommended.

Fredrik Bodecker - Echelon Trading AB

Criador Labs managed to finish my project exactly on time, and exactly as I needed it. I would happily use them again any time!

Brad

Brilliant guys to work with, Have done quite a few 3D renders now with Hitesh and the guys and am very pleased. They are very creative and have great attention to detail. Would definitely recommend

StephenMcGuinness

Good communications. Performed sooner than expected. Did more than contracted for with no extra charge. Would hire again.

Richard DeRoberts - CEO, WELLRAY MEDICAL LASER, Inc.

Hitesh was very responsive and an excellent communicator. His concept presentations were excellent. Hitesh made every effort to accommodate my needs.

Steven Adam - Intelligent Movement Solutions Pty. Ltd.

I strongly recommend Criador Labs , they are reliable, keep their promise, never give-up and accomplish the task until the desired result. i will work again as my design partner for future projects too.

Levent Dokuzoglu

It has been a wonderful experience working with Hitesh. He has exceeded my expectations. Words can not describe how appreciative I am for all he has done for us. He has assumed ownership of our project as if it was his own and that speaks volumes of his character.

David Marrero

Very quick & good communication.

Doug Karlson - Heat Wave Visual

I started out with a small order, and because of the level of service and high quality work, I ordered several more services. These guys feel like an extension of my business. Highly recommended!

"Christian Johnson" - President - BeautifulBrains, LLC/ Driver Watchdog

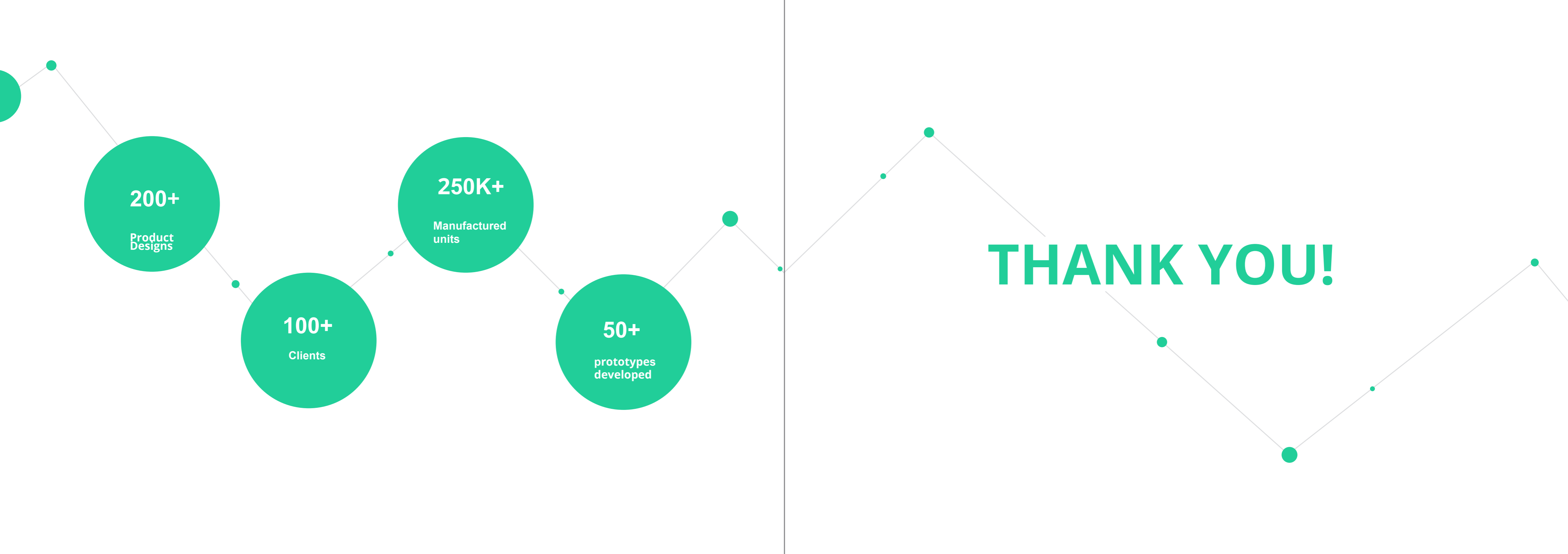

200+

Product Designs

100+

Clients

250K+

Manufactured units

50+

prototypes developed

THANK YOU!



CONTACT US

Address:

No.408, 3rd Floor,
5th Main, 2nd Block,
HRBR Layout,
Bengaluru - 560043

Email:

info@criadorlabs.com

Phone :

+91 99286-09789